

# RUBIDIUM ATOMIC FREQUENCY STANDARDS

Low Cost Atomic Standards...The Perfect  
Replacement for Precision Quartz.  
Low Phase Noise for Communications  
and Timing Systems



FE-5650A



FE-5652A



FE-5660A

FE-5680A



**FEI Communications, Inc.**

北京建普奇正技术发展有限公司

电话：86+10+68118120 传真：86+10+68118130

网址：www.ojumpo.cn

地址：北京市海淀区中关村南大街31号 神舟大厦 709

### FE-5650A

- EXTREMELY SMALL: 3x3x1.4 IN.
- DIGITALLY PROGRAMMABLE TO  $1 \times 10^{-13}$
- FREQUENCY: 1 Hz TO 20 MHz & 50.255+MHz
- STABILITY OVER TEMPERATURE  $3 \times 10^{-10}$
- STABILITY:  $1.4 \times 10^{-11} / \sqrt{t}$ ,  $2 \times 10^{-11} / \text{DAY}$   
 $2 \times 10^{-9} / \text{YEAR}$

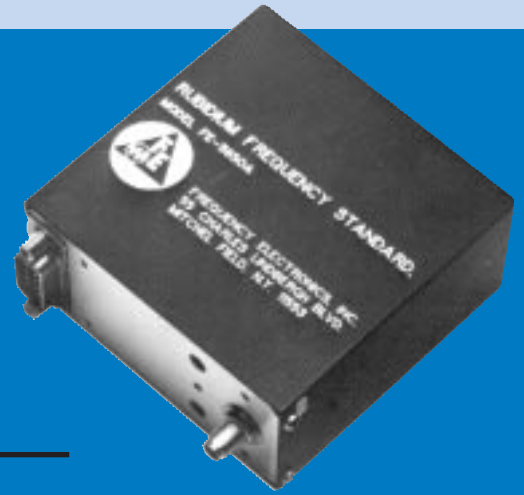

### FE-5652A

- TEMPERATURE RANGE:  $-40^{\circ} \text{C}$  to  $+85^{\circ} \text{C}$
- STABILITY OVER TEMPERATURE:  $5 \times 10^{-11}$
- DIGITALLY PROGRAMMABLE TO  $1 \times 10^{-13}$
- FREQUENCY: 1 Hz TO 20 MHz
- FAST WARM UP:  $<5 \text{ MIN}$
- STABILITY: TO  $5 \times 10^{-12} / \sqrt{t}$   
 $2 \times 10^{-10} / \text{YEAR}$



### FE-5660A

- STANDARD OUTPUT FREQUENCY IS 5 OR 10 MHz
- SHORT TERM: ALLAN DEVIATION  $3 \times 10^{-11} / \sqrt{t}$
- LONG TERM: AGING  $5 \times 10^{-11} / \text{MONTH}$
- TEMPERATURE:  $3 \times 10^{-10}$ ,  $-5$  TO  $+50^{\circ} \text{C}$



### FE-5680A

- EXTREMELY LOW SILHOUETTE: LESS THAN 1"
- STABILITY OVER TEMPERATURE:  $5 \times 10^{-11}$
- DIGITALLY PROGRAMMABLE TO  $1 \times 10^{-13}$
- FREQUENCY: 1 Hz TO 20 MHz
- FAST WARM UP:  $<5 \text{ MIN}$
- STABILITY: TO  $5 \times 10^{-12} / \sqrt{t}$   
TO  $2 \times 10^{-10} / \text{YEAR}$



## SPECIFICATIONS

<b>FREQUENCY</b>	10 MHz (Factory Settable 1 Hz to 20 MHz)
<b>OUTPUT</b>	0.5V rms into 50 ohm sinewave
<b>SETTABILITY</b>	$1 \times 10^{-11}$ (range $2 \times 10^{-9}$ )
<b>STABILITY</b>	
<b>ALLAN DEVIATION</b>	$1.4 \times 10^{-11} / \sqrt{t}$
<b>DRIFT</b>	$2 \times 10^{-9}$ /year $2 \times 10^{-11}$ /day
<b>RETRACE</b>	$5 \times 10^{-11}$
<b>INPUT VOLTAGE</b>	
<b>SENSITIVITY</b>	$2 \times 10^{-11}$ /15 to 16V
<b>SPURS</b>	60 dBc
<b>HARMONICS</b>	30 dBc
<b>PHASE NOISE</b>	@ 10 Hz: -100 dBc
(@ 10 MHz)	@ 100 Hz: -125 dBc @ 1000 Hz: -145 dBc
<b>FREQUENCY VS TEMP.</b>	$3 \times 10^{-10}$ (-5 to +50°C)

BITE Output, No Fault/Fault LOGIC LEVEL Rb Lock, 0/1 (TTL Compatible)

## TECHNICAL CHARACTERISTICS

<b>MODEL</b>	FE-5650A	FE-5652A	FE-5660A	FE-5680A
<b>POWER @25°C</b>	8W (Steady State) 32W(Peak)	16W (Steady State) 36W (Peak)	10W @24 VDC -----	11W (Steady State) 32W (Peak)
<b>WARM-UP TIME @25°C</b>	<4 min. to lock	5 min to lock	<6 min. to $1 \times 10^{-9}$	<5 min. to lock
<b>POWER SUPPLY</b>	15-18V @500 mA 5V $\pm$ 0.25 @100 mA	26 to 28 VDC	15V	15-18V @700 mA
<b>RIPPLE INPUT</b>	15V @< 0.1 Vrms	-----	-----	15V @< 0.1 Vrms
<b>OPERATING</b>	<b>or 48 bit DDS</b>			<b>or 48 bit DDS</b>
<b>TEMPERATURE</b>	-5°C to +50°C	-40 to +85°C	-5° to +50°C	-5°C to +50°C
<b>SIZE</b>	1.44 x 3.03 x 3.00 37 x 77 x 76 mm 12 oz, 338 gms	2.97 x 6.0 x 6.3 75 x 178 x 160 mm 3.06 Lbs, 1.388 Kgs	2 x 3 x 4 51 x 76 x 102 mm 1.3 Lbs, 0.6 Kgs	0.98 x 3.4 x 4.92 25 x 88 x 125 mm 15.3 oz, 434 gms

Typical Phase Noise vs. Frequency @ 10MHz

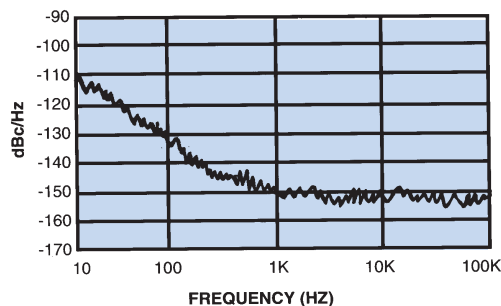

Figure 1

# RUBIDIUM FREQUENCY STANDARDS

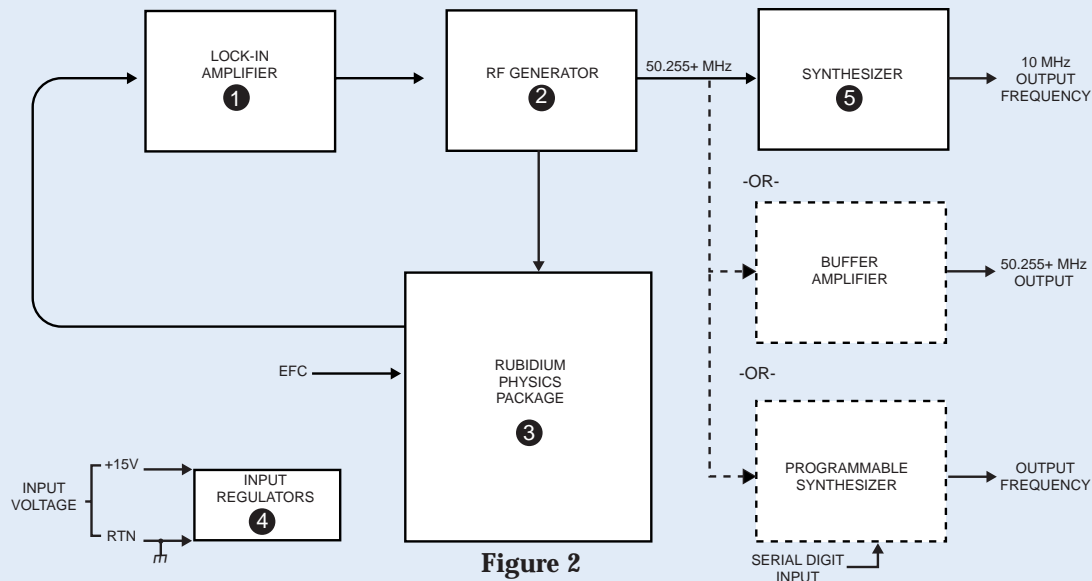

Figure 2

## FUNCTION DESCRIPTION

The RFS uses the property of atomic resonance in a Rubidium Physics Package to control the output frequency of a 50.255+ MHz Voltage Controlled Crystal Oscillator (VCXO) via a Frequency Lock Loop (FLL). The FLL functional blocks consist of an RF Generator, Lock-in Amplifier and the Rubidium Physics Package. Frequency locking of the VCXO is accomplished by operating the Rubidium Physics Package as a frequency discriminator, i.e., departures of a frequency derived from an input signal (50.255+ MHz from the VCXO) from a defined center frequency (Rubidium atomic resonance) produce a DC output signal (control voltage). Once the FLL has been established, the system generates a loop-locked indication which can be monitored on pin 3. Depending on the option selected, the 50.255+ MHz VCXO output is used as the clock input for the DDS within the Synthesizer, the Digital Programmable Synthesizer or Buffer Amplifier.

The Rubidium Physics Package utilizes the ground-state hyperfine transition of the Rubidium atom, at approximately 6.8+ GHz. In order to use this atomic transition, the Rubidium Physics Package incorporates a Rubidium cell, Rubidium lamp, and servo electronics. The VCXO is locked to the Rubidium atomic resonance at 6.8+ GHz. The VCXO frequency of 50.255+ MHz is an exact sub-multiple ( $\times 136$ ) of the atomic resonance frequency at 6.8+ GHz.

The error signal is generated in the physics package. Light from the Rubidium lamp, produced by an excited plasma discharge, is filtered and passed through the Rubidium resonance cell where it interacts with Rubidium atoms in the vapor. After passing through the resonance cell, this light is incident upon a photodiode. When the applied microwave frequency is equal to 6.8+ GHz, the Rubidium atoms are resonated by the microwave field in the cavity; this causes the light reaching the photodiode to decrease. The decrease in light, when the microwave frequency is equal to the sharply defined Rubidium frequency, is then converted electronically to an error signal with phase and amplitude information that is used to steer the VCXO via its control voltage and keep it on frequency at 50.255+ MHz.

Output frequencies for Options 02 are provided by the Digital Programmable Synthesizer. Option 02 is an RS-232 remote digitally controlled output with a frequency range of  $2 \times 10^7$  at a resolution of  $5 \times 10^{-12}$ .

# OPTIONS

OPTION NO.	OUTPUT FREQUENCY
**01	50.255055 MHz Sine Wave
03	5 MHz
04	15 MHz
05	13 MHz
06	2.048 MHz
07	10.23 MHz
***08	Customer Frequency

\*\*Nominal Frequency  $\pm 5 \times 10^{-8}$

\*\*\*1 Hz to 10 MHz sq. wave, TTL Comp., 5 MHz to 20 MHz sine wave.

OPTION	INPUT VOLTAGE OPTIONS
20	15 VDC
25	22 VDC to 32 VDC
34	15 & 5 VDC Input (FE-5660)
46	Reverse Voltage Protection

OPTION NO.	FREQUENCY STABILITY
28	$4 \times 10^{-12}$ /day, $5 \times 10^{-10}$ /year
29	$2 \times 10^{-10}$ /year after 1 year ( $4 \times 10^{-10}$ /month)
31	Allan Dev = $5 \times 10^{-12} / \sqrt{t}$
32	f vs. T = $\pm 1 \times 10^{-10}$
48	f vs. T = $\pm 5 \times 10^{-11}$

OPTION	OUTPUT CHARACTERISTICS
02	RS232 control*
09	Square Wave
12	Analog Tuning
16	-80 dBc Spurious for $\pm 5$ MHz
21	1.0 V <sub>rms</sub> Output
26	LOCK=TTL High
30	Analog Tuning: 0 to 10v
35	$7 \times 10^{-9}$ C-Fld Adj

\*Consult factory

OPTION	OTHER
18	Conformally Coated
22	MIL environment (foamed)
46	Reverse Voltage Protection

OPTION	TEMPERATURE RANGE
36-44	Consult Factory (from -55°C to +85°C)

## APPLICATIONS

Rubidium atomic frequency standards are being used increasingly in telecommunication applications, particularly wireless telephone networks. The possibility of frequency stability sufficient to eliminate the need for scheduled re-calibrations, along with small size, low power requirements, wide temperature range operation, and low cost, make these devices attractive candidates for telecommunication applications.

In this paper, two new Rb frequency standard designs the FE5680A and FE5652A have been optimized for such applications. The first design is a low profile device, in a package less than 1 inch in height. This device is designed to operate over the temperature range -10 to +60°C, with less than 1E-10 frequency error.

The second design is a wide temperature range device, which operates from -40 to +85°C, with less than 1E-10 frequency error. This unit employs a thermo-electric cooler to maintain the Rb absorption elements at acceptable temperatures at the high end of the ambient temperature range.

These devices are presently in production. Performance results of production devices are presented.

### Introduction

The FE-5680A Rb frequency standard is 3.5 x 5 x 1 inches, a design suited to PC board slot mounted applications. This product is shown in Figure 1. A simplified functional block diagram is shown below. (Figure 3)

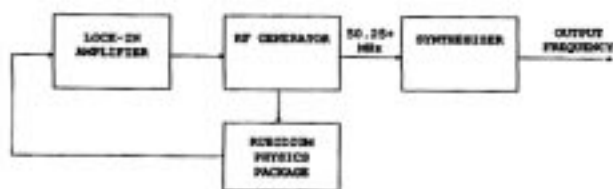

Figure 3

The FE-5652A Rb frequency standard is 4.7 x 6 x 3 inches. This larger package allows space for a thermo-electric cooler for the physics package, as well as circuitry to lock the output frequency to a 1 PPS reference signal as provided by GPS receivers. This product is shown in Figure 3. A simplified block diagram is shown below.

Many commercial applications for precision frequency standards demand performance over an extended temperature range. Often frequency variation with temperature is the performance-limiting feature of these devices for CDMA holdover applications. The two products described in this paper

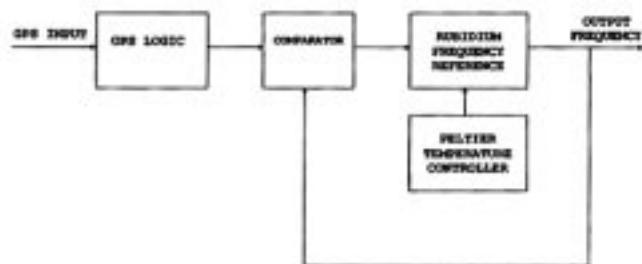

Figure 4  
Block Diagram, FE-5652A

have both been designed to operate over extended temperature ranges while guaranteeing a frequency variation of less than 1E-10. The FE-5680A operates at any temperature between -10 and +60°C, a temperature range required for indoor rack-mounted telecommunication hardware with limited air flow. The FE-5652A operates at any temperature between -40 and +85°C, a temperature range required for outdoor, limited access, low maintenance telecommunication hardware.

### General Performance Characteristics

Performance characteristics for these Rb frequency standards are shown in electrical characteristics and options. It is immediately apparent the performance of the two designs is very similar. The only differences are that the FE-5652A requires a 28 VDC (nominal) input, and whereas the FE-5680A requires a 15 VDC (nominal) input. The power dissipation of the FE-5652A is 16 watts, as opposed to the 11 watts dissipated by the FE-5680A. The extra power required for the FE-5652A is needed for the thermo-electric circuit and the external reference lock circuitry.

### Frequency vs. Temperature

As mentioned above, frequency variations due to ambient temperature variations can easily swamp other sources of instability for a Rb frequency standard operating in a real life environment. Therefore special attention was given to frequency stability vs. temperature in these designs. Figures 5 and 6 show typical performance data for FE-5680A and FE-5652A Rb standards over the ambient temperature range. In addition to the information provided by these plots, it is useful to understand the distribution of performance associated with a production lot of these devices. Table 2 provides this information.

# APPLICATIONS

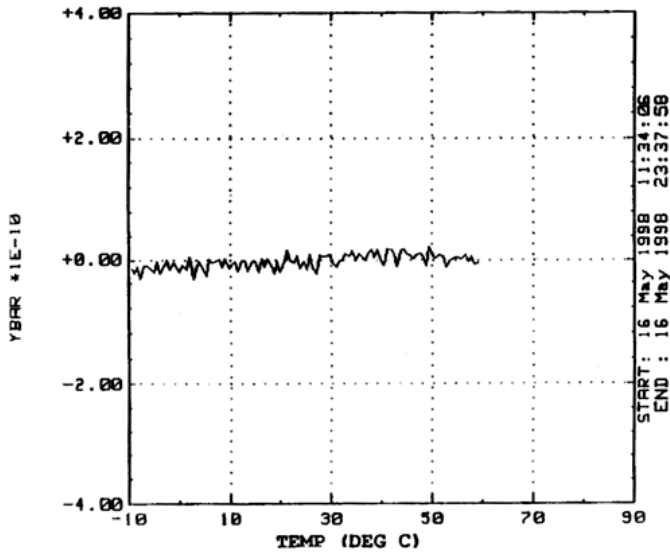

Figure 5  
Frequency vs Temperature, FE-5680A

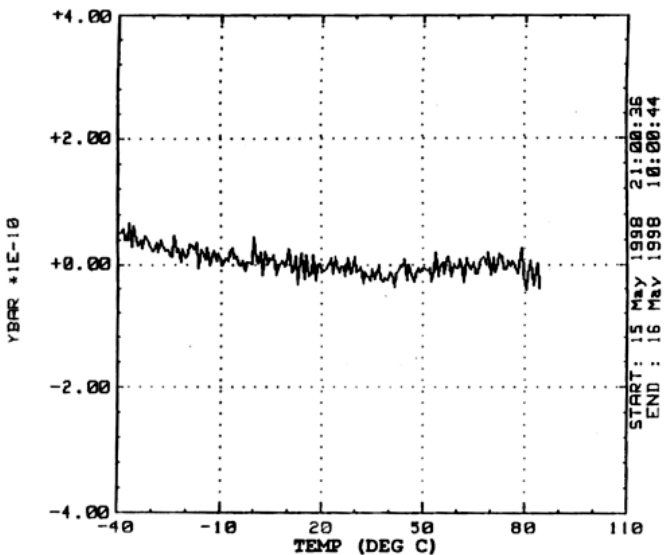

Figure 6  
Frequency vs Temperature, FE-5652A

Table 2  
Frequency vs. Temperature Statistics, FE-5680A

Lot ID	No. of Units	Mean $\Delta f$ (E <sup>-10</sup> )	Std. Dev. (E <sup>-10</sup> )
43	34	0.00	0.304
44	36	-0.09	0.416

The information in this table shows that the mean total frequency deviation over temperature is very small. What this really means is that the frequency deviation is equally likely to be positive or negative. The standard deviation values give an indication of the range of deviations to be expected amongst production devices.

## Frequency Stability

Allan deviation stability data for the FE5680A and FE5652A Rb standards are shown in Figure 7. The measurements used to derive the Allan deviation were all made at 25°C. It is of interest to note that the result for SN 4005 is significantly improved by comparing it to another Rb standard (SN 5339) rather than a Cs reference. This indicates that the result is limited by the stability of the Cs reference.

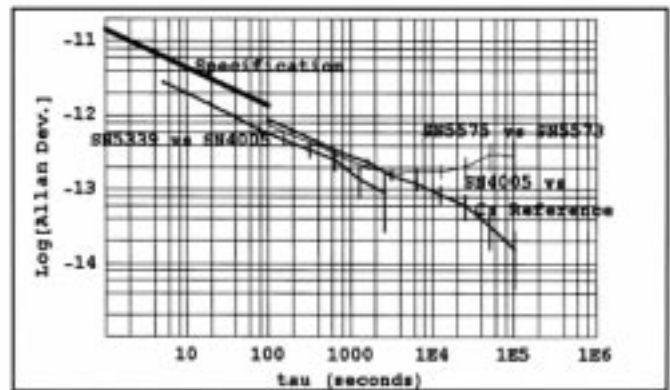

Figure 7  
Allan Variance for several units  
Summary

Performance results for two new Rubidium frequency standard products have been reported. These products continue the trend toward small, robust, high-performance atomic frequency standards capable of operating in harsh non-laboratory environments, yet providing stabilities approaching those measured under controlled laboratory conditions. These devices are well suited to the demands of the telecommunications industry for increasingly precise time and frequency references capable of operating un-attended in harsh environments.



# TIME/FREQUENCY ERROR CONVERSION CHART

## FOR CONSTANT FREQUENCY OFFSET

EXAMPLE: In this chart a fractional frequency offset of  $2PP10^9$  will yield an accumulated error of .01 microseconds/5 seconds.

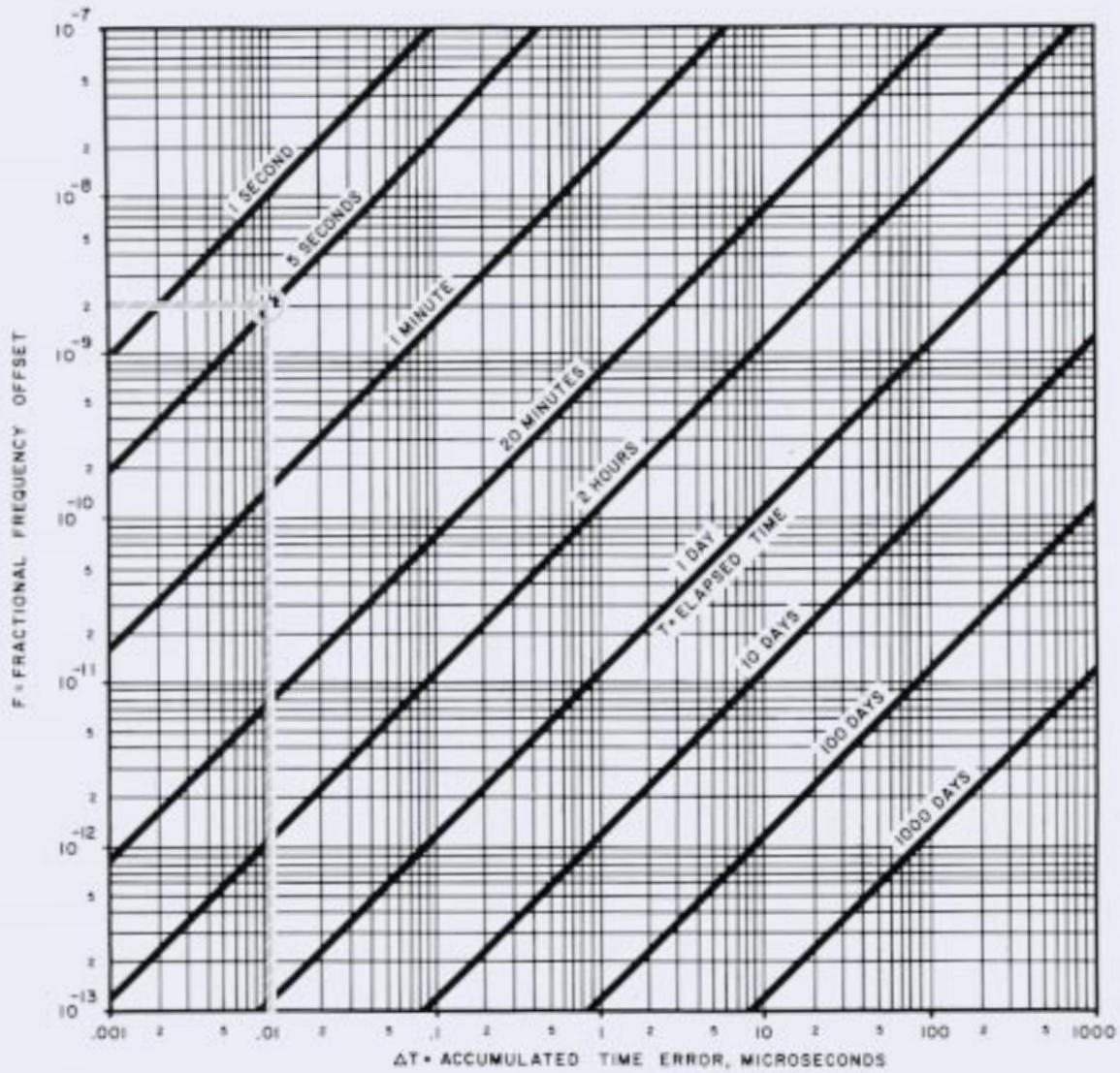

$$\Delta T = 8.64 \times 10^{10} \frac{F T}{\text{MICROSEC}}$$

DAYS

CHART 1



# TIME/FREQUENCY ERROR CONVERSION CHART

## FOR LINER FREQUENCY DRIFT

In this chart a fractional frequency drift rate of  $2PP10^{11}$  per day will yield an accumulated error of 0.10 microseconds per 8 hours for an initial offset of zero.

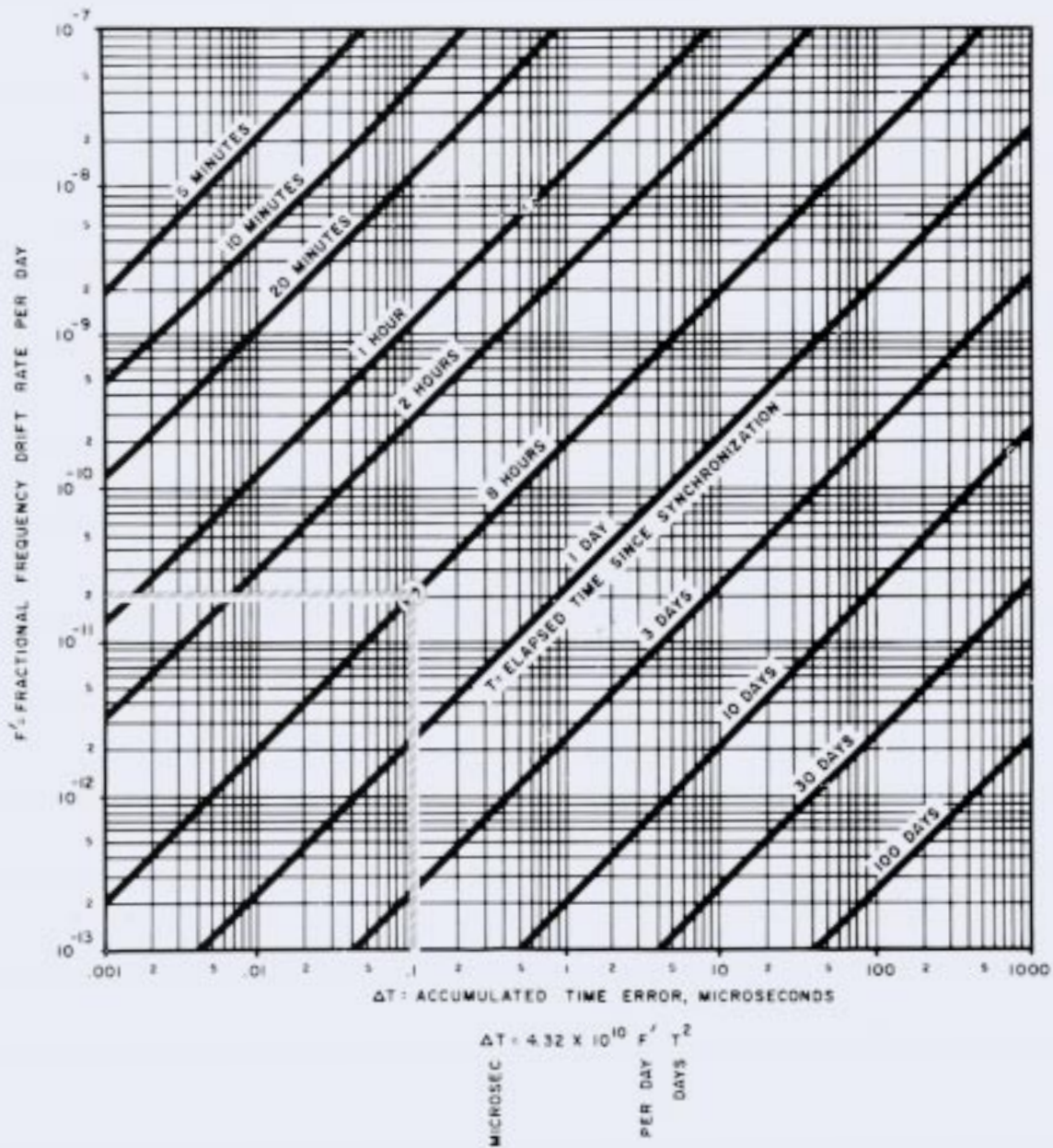

CHART 2

# 5650A

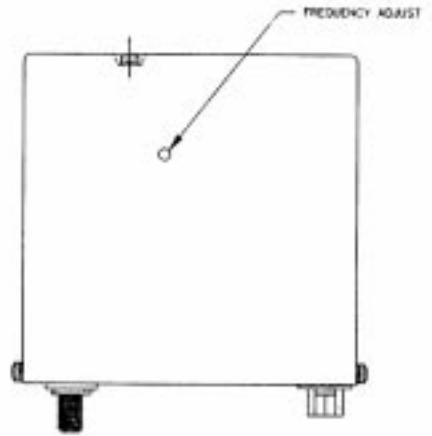
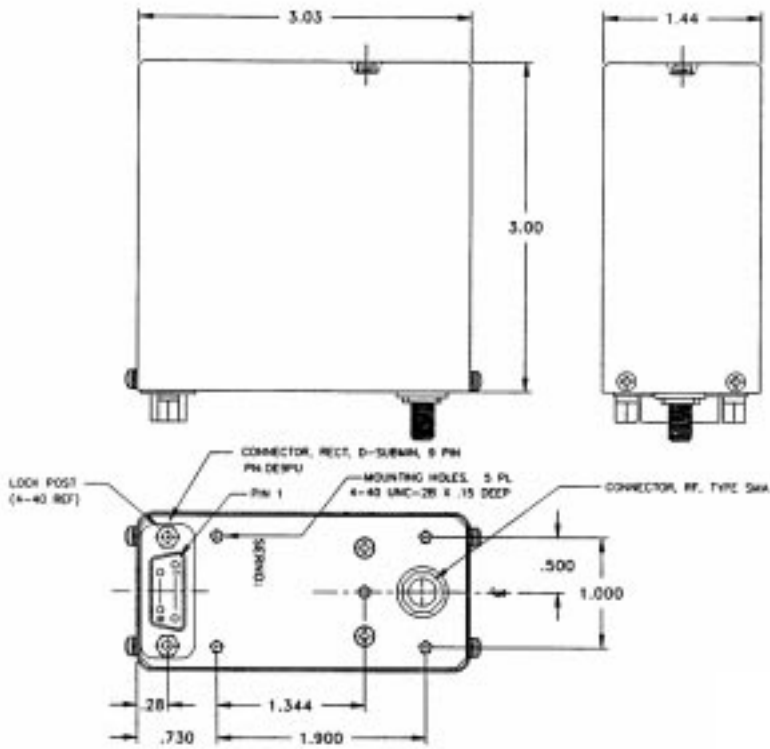
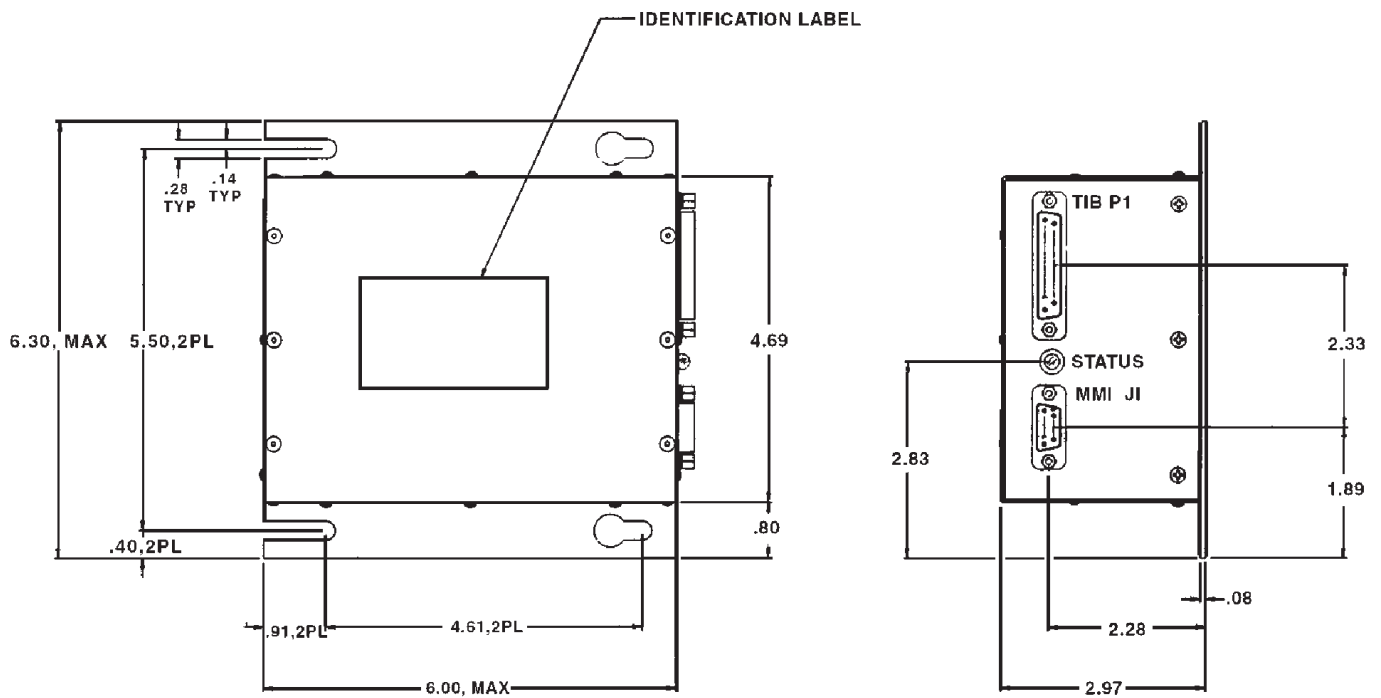

TABLE 1

PIN	FUNCTION
1	+15V
2	+15V RTN
3	LOCK INDICATOR (BIT)
4	+5V
5	+5V RTN
6	NC
7	FINE TUNE RTN
8	FINE TUNE
9	NC

PART NUMBER OF THIS DEVICE IS CONTROLLED BY CCD B115010-13480

# 5652A



# 5660A

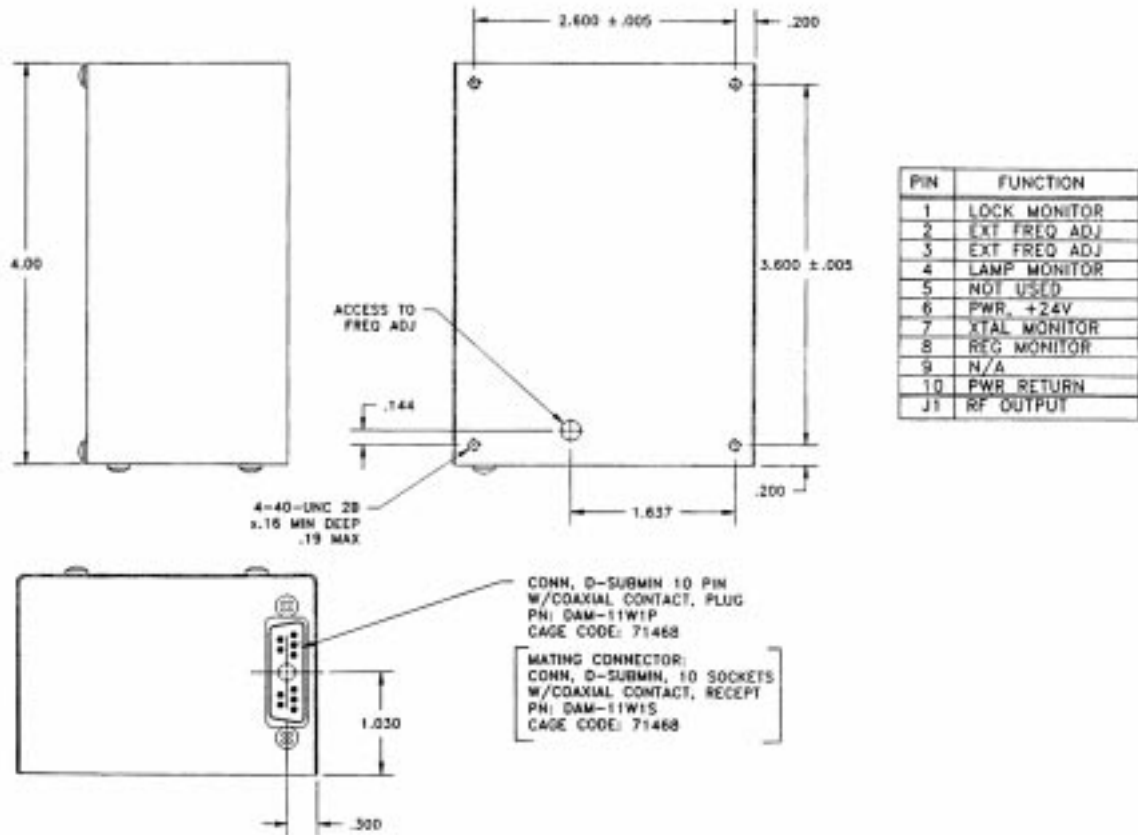

# 5680A

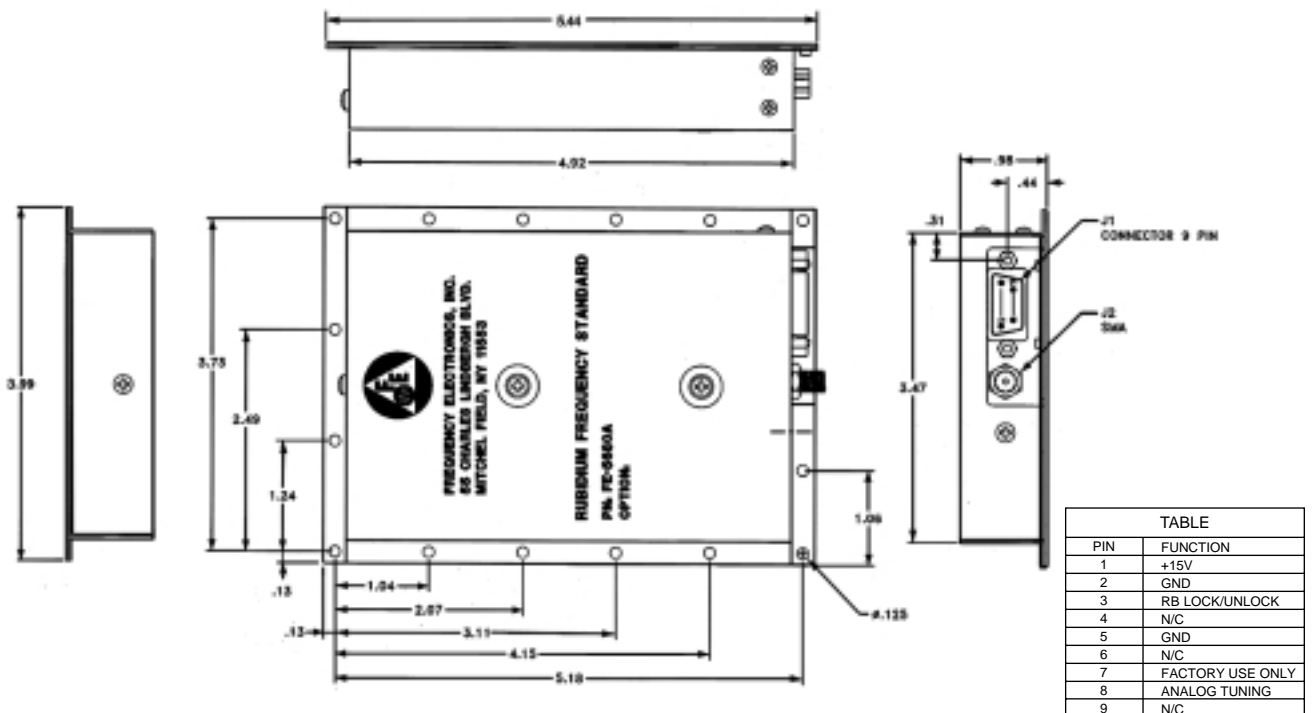

# OTHER FEI PRODUCTS

## FE-102A - CRYSTAL OSCILLATOR

OPERATION @100 MHz  
WITH LOW PHASE  
NOISE: -172 dBc



## FE-101A - CRYSTAL OSCILLATOR

SUBMINIATURE OVEN CONTROLLED DESIGN,  
ONLY 1.27"X1.33"X1.33"  
WITH FAST WARM UP -  
LESS THAN 2 MINUTES

## FE-103A - CRYSTAL OSCILLATOR

DOUBLE OVEN DESIGN  
WITH EXCELLENT STABILITY:  
 $1 \times 10^{-11}$ /SEC



## FE-7923A - DISTRIBUTION AMPLIFIER

AN ECONOMICAL, 10-CHANNEL SINEWAVE  
DISTRIBUTION AMPLIFIER  
OPERATING FROM 1 MHz  
THROUGH 10 MHz

北京建普奇正技术发展有限公司  
电话：86+10+68118120 传真：86+10+68118130  
网址：www.ojumpo.cn  
地址：北京市海淀区中关村南大街31号神舟大厦709室