

8inch PFA Cassette

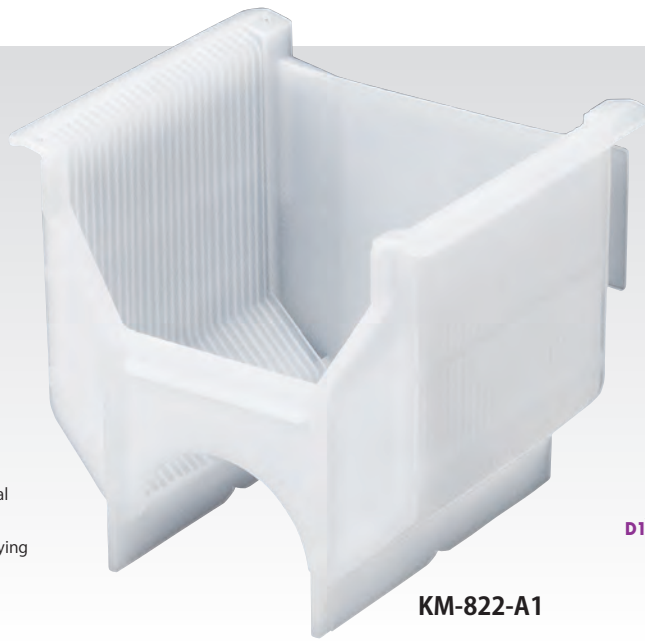

200
mm

- KM-80NA是隔阅齿距4.76mm与以前的150mm晶片盒的全长是相同的
- KM-804-H由半型盒子而清洗, 最合于干燥用

•KM-80NA: 4.76 mm slot pitch and same length as conventional 150mm cassettes
 •KM-804-H: half-type cassette ideally suited to washing and drying

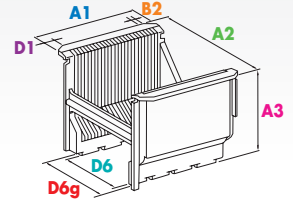

KM-822-A1

产品号码 Number	材料性质 Material	存放片数 Wafer Capacity	A1 全长 Length (mm)	A2 最大宽度 Width (mm)	A3 全高 Height (mm)	D1 D1尺寸 D1 Dimension (mm)	B2 隔阅齿距 Slot Pitch (mm)	D6 腿内面的尺寸 Foot Width(Inner) (mm)	D6g 腿外面的尺寸 Foot Width(Outer) (mm)
KM-80NA	PFA	25	152.40	250.00	220.00	19.05	4.76	120.00	132.00
KM-803-H	PFA	25	203.20	240.00	217.40	25.40	6.35	114.30	126.30
KM-804-H	PFA	25	203.20	240.00	155.00	25.40	6.35	114.30	126.30
KM-822-A1	PFA	25	203.20	240.00	217.40	25.40	6.35	114.30	126.30
KM-822-A2	PFA	25	203.20	240.00	217.40	25.40	6.35	114.30	126.30

8inch PEEK Cassette

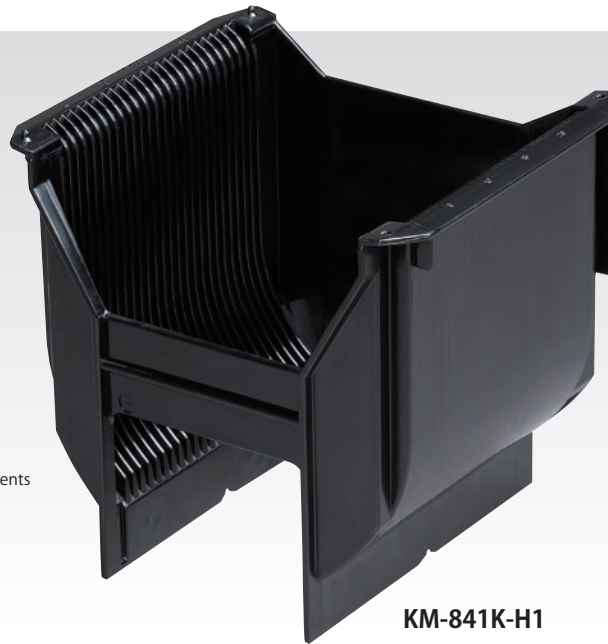

200
mm

- 用来对静电PEEK盒子, 并且可以在高温阶段使用
- KM-841K-H2/H4是SOI用的晶片(t1.45mm)使用的盒子

•Antistatic PEEK cassette withstands high temperature environments
 •KM-841K-H2/H4 cassette: for SOI wafers (t 1.45 mm)

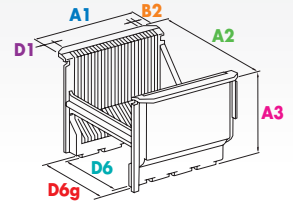

KM-841K-H1

产品号码 Number	材料性质 Material	存放片数 Wafer Capacity	A1 全长 Length (mm)	A2 最大宽度 Width (mm)	A3 全高 Height (mm)	D1 D1尺寸 D1 Dimension (mm)	B2 隔阅齿距 Slot Pitch (mm)	D6 腿内面的尺寸 Foot Width(Inner) (mm)	D6g 腿外面的尺寸 Foot Width(Outer) (mm)
KM-839K-A1	PEEK+CP	26	209.55	235.00	219.00	25.40	6.35	114.30	122.30
KM-839K-A3	PEEK+CP	26	209.55	235.00	219.00	25.40	6.35	114.30	122.30
KM-841K-H1	PEEK+CP	25	203.20	234.18	219.08	25.40	6.35	114.30	122.30
KM-841K-H2	PEEK+CP	25	203.20	234.18	219.08	25.40	6.35	114.30	122.30
CW-08KE	PEEK+CP	25	203.20	240.00	217.40	25.40	6.35	114.30	126.30
CW-08KE-T	PEEK+CP	25	203.20	240.00	217.40	25.40	6.35	114.30	126.30

8inch NEO Cassette



KM-834NE-H

KM-854NE-H4

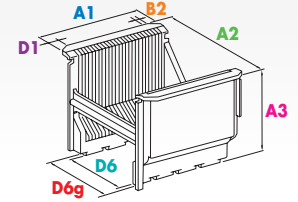

- 由PBT为基本用导电材复合的材料使用
- 带电防止型PBT盒子
- KM-854NE-H4是装13片双倍齿距盒子, 可以用在各种各样厚度的晶片上

- Compound conductive materials on a PBT base
- Antistatic PBT cassette
- KM-854NE-H4 is Double-Pitch Cassette which contains 13 various thickness wafers

产品号码 Number	材料性质 Material	存放片数 Wafer Capacity	A1 全长 Length (mm)	A2 最大宽度 Width (mm)	A3 全高 Height (mm)	D1 D1尺寸 D1 Dimension (mm)	B2 隔齿齿距 Slot Pitch (mm)	D6 腿内面的尺寸 Foot Width(Inner) (mm)	D6g 腿外面的尺寸 Foot Width(Outer) (mm)
KM-834NE-H	NEO	25	203.20	234.18	218.18	25.40	6.35	114.30	122.30
KM-854NE-A	NEO	26	209.55	235.00	219.00	25.40	6.35	114.30	122.30
KM-854NE-H	NEO	26	209.55	235.00	219.00	25.40	6.35	114.30	122.30
KM-854NE-H4	NEO	13	209.55	235.00	219.00	28.60	12.70	114.30	122.30
KM-855NE-A	NEO	25	203.20	235.00	219.00	25.40	6.35	114.30	122.90
KM-855NE-H	NEO	25	203.20	235.00	219.00	25.40	6.35	114.30	122.90

6inch PFA Cassette

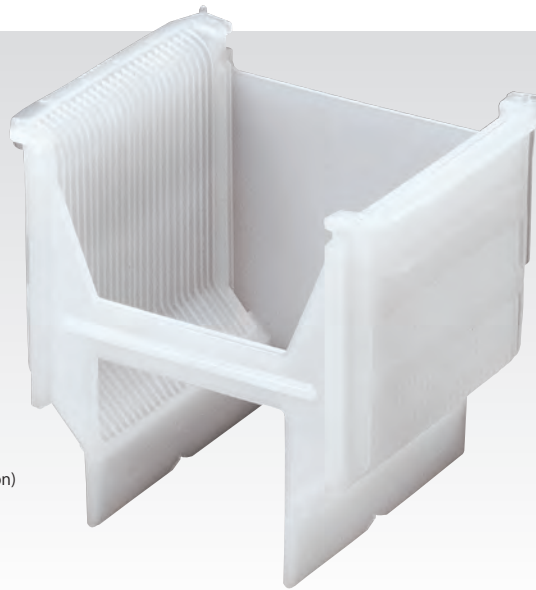

150
mm

- 重视刚性 (防止变形), 重视清洗性 (开孔面积广阔)

- Designed with emphasis given to rigidity (deformation prevention) and washability (wide openings)

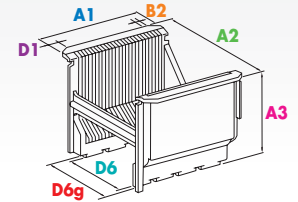

KM-615-A1

产品号码 Number	材料性质 Material	存放片数 Wafer Capacity	A1 全长 Length (mm)	A2 最大宽度 Width (mm)	A3 全高 Height (mm)	D1 D1尺寸 D1 Dimension (mm)	B2 隔齿齿距 Slot Pitch (mm)	D6 腿内面的尺寸 Foot Width(Inner) (mm)	D6g 腿外面的尺寸 Foot Width(Outer) (mm)
KM-60NA	PFA	25	142.24	187.00	165.00	13.97	4.76	89.00	100.00
KM-60NAT	PFA	25	142.81	178.00	171.45	14.54	4.76	89.00	100.00
KM-60NM	PFA	25	142.24	187.00	165.00	13.97	4.76	131.00	142.00
KM-60WD	PFA	25	134.33	177.80	171.45	14.54	4.76	111.00	120.00
KM-602-A	PFA	25	143.38	178.00	171.50	14.54	4.76	89.00	100.00
KM-602-U	PFA	25	143.38	178.00	171.50	14.54	4.76	89.00	100.00
KM-604-U	PFA	25	142.24	187.00	165.00	13.97	4.76	89.00	100.00
KM-615-A1	PFA	25	143.38	177.80	171.50	14.54	4.76	88.90	98.50
KM-623-U	PFA	25	143.38	177.80	165.00	14.54	4.76	88.90	100.90
KM-626-U	PFA	25	143.38	177.80	165.00	14.54	4.76	88.90	100.90

Before use, please inquire about and confirm details of outer dimensions separately.

6inch PEEK Cassette

- 用来对静电PEEK盒子,并且可以在高温阶段使用
- KM-632K-SA是SOI用的晶片(t1.45mm)使用的盒子和200mm盒子的全长相同

• Antistatic PEEK cassette withstands high temperature environments
 • KM-632K-SA cassette: for SOI wafers (t 1.45 mm), but with same length as 200 mm cassettes



KM-627K-SH

150
mm

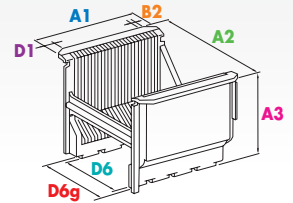

产品号码 Number	材料性质 Material	存放片数 Wafer Capacity	A1 全长 Length (mm)	A2 最大宽度 Width (mm)	A3 全高 Height (mm)	D1 D1尺寸 D1 Dimension (mm)	B2 隔间齿距 Slot Pitch (mm)	D6 腿内面的尺寸 Foot Width(Inner) (mm)	D6g 腿外面的尺寸 Foot Width(Outer) (mm)
KM-627K-SA	PEEK+CP	25	143.38	177.80	164.00	14.54	4.76	88.90	100.90
KM-627K-SH	PEEK+CP	25	143.38	177.80	164.00	14.54	4.76	88.90	100.90
KM-628K-SH	PEEK+CP	26	149.64	177.80	164.00	14.54	4.76	88.90	100.90
KM-632K-SA	PEEK+CP	25	203.20	177.80	164.00	25.40	6.35	88.90	100.90
CW-06	PEEK	25	143.38	177.80	165.10	14.54	4.76	88.90	100.00
CW-06KE-T1	PEEK+CP	25	143.38	177.80	165.10	14.54	4.76	88.90	100.00
CW-06KE-T2	PEEK+CP	25	143.38	177.80	165.10	14.54	4.76	88.90	100.00

6inch NEO Cassette

- 由PBT为基本用导电材复合的材料使用
- KM-610NE-A2是装12片双倍齿距盒子,可以用在各种各样厚度的晶片上

• Antistatic PBT cassette made using compound conductive materials on a PBT base
 • KM-610NE-A2 is Double-Pitch Cassette which contains 12 various thickness wafers



KM-627NE-SA



KM-610NE-A2

150
mm

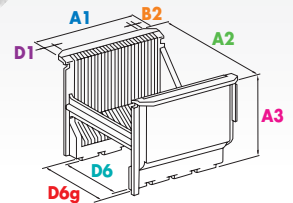

产品号码 Number	材料性质 Material	存放片数 Wafer Capacity	A1 全长 Length (mm)	A2 最大宽度 Width (mm)	A3 全高 Height (mm)	D1 D1尺寸 D1 Dimension (mm)	B2 隔间齿距 Slot Pitch (mm)	D6 腿内面的尺寸 Foot Width(Inner) (mm)	D6g 腿外面的尺寸 Foot Width(Outer) (mm)
KM-627NE-SA	NEO	25	143.38	177.80	163.60	14.65	4.76	88.90	100.90
KM-627NE-SH	NEO	25	143.38	177.80	163.60	14.65	4.76	88.90	100.90
KM-631NE-H	NEO	25	142.24	187.50	165.00	13.97	4.76	89.00	99.40
KM-654NE-H	NEO	26	147.00	187.00	165.00	13.97	4.76	89.00	100.00
KM-610NE-A2	NEO	12	142.81	168.00	163.50	21.68	9.525	89.00	95.00

6inch PBT/PP Cassette

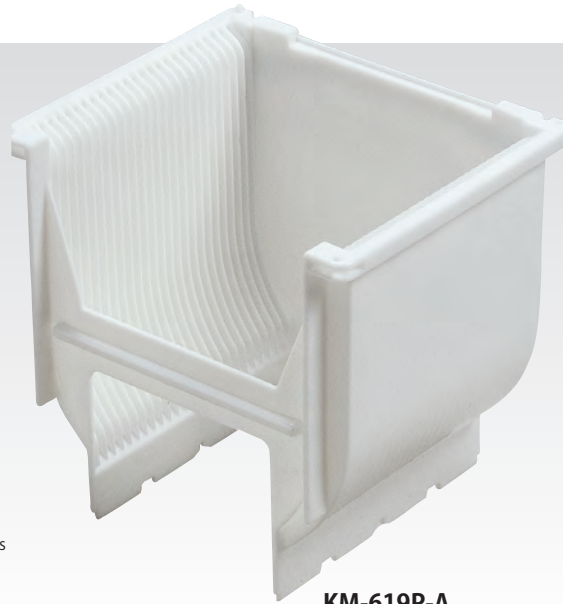

150
mm

- 低削, 低释气(PBT)
- 相对抵抗药品性能很能(PP)
- KM-610T-A2是装12片双倍齿距盒子, 可以用在各种各样厚度的晶片上

- Abrasion resistant and low outgas cassette (PBT)
- Comparatively strong resistance to chemicals (PP)
- KM-610T-A2 is Double-Pitch Cassette which contains 12 various thickness wafers

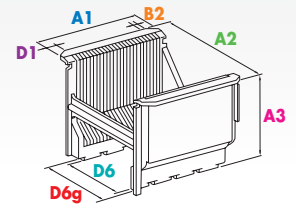

KM-619P-A

产品号码 Number	材料性质 Material	存放片数 Wafer Capacity	A1 全长 Length (mm)	A2 最大宽度 Width (mm)	A3 全高 Height (mm)	D1 D1尺寸 D1 Dimension (mm)	B2 隔齿齿距 Slot Pitch (mm)	D6 腿内面的尺寸 Foot Width(Inner) (mm)	D6g 腿外面的尺寸 Foot Width(Outer) (mm)
KM-60PN	PP	13	142.70	187.00	165.00	14.20	9.525	132.70	142.70
KM-60PA	PP	25	142.24	187.00	165.00	14.54	4.76	89.00	95.00
KM-60PA2	PP	25	142.24	187.00	165.00	13.97	4.76	89.00	94.20
KM-602P-A	PP	25	142.98	178.00	165.00	14.54	4.76	89.00	98.00
KM-602P-U	PP	25	142.98	178.00	165.00	14.54	4.76	89.00	98.00
KM-602P-H	PP	25	142.98	178.00	165.00	14.54	4.76	89.00	98.00
KM-610T-A2	PBT	12	142.81	168.00	163.50	21.68	9.525	89.00	95.00
KM-619P-A	PBT	25	142.80	168.00	163.50	14.54	4.76	89.00	95.00

5inch PFA Cassette

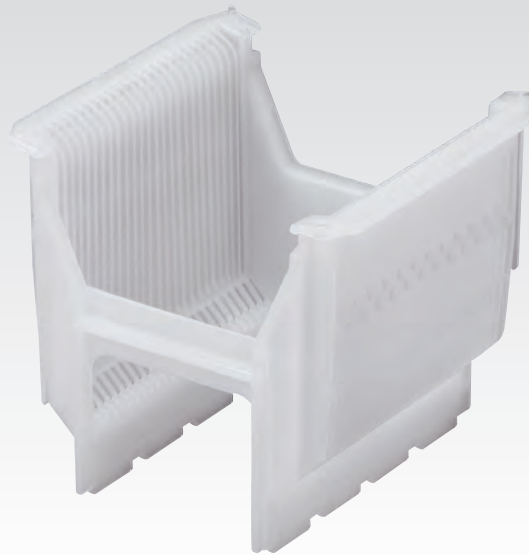

125
mm

- 重视刚性 (防止变形), 重视清洗性 (开孔面积广阔)
- K-1,K-2与150mm盒子的外形尺寸相同
- 使KM-510A的齿距变得狭窄, 因此一次能收藏50片的晶片

- Designed with emphasis given to rigidity (deformation prevention) and washability (wide openings)
- K-1 and K-2 are 125mm wafer cassette which have 150mm wafer cassette's silhouette
- Narrow slot pitch enables the KM-510A to hold 50 wafers at once

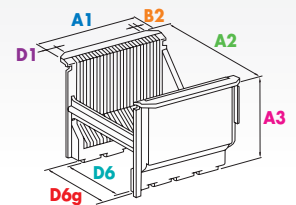

KM-507-U

产品号码 Number	材料性质 Material	存放片数 Wafer Capacity	A1 全长 Length (mm)	A2 最大宽度 Width (mm)	A3 全高 Height (mm)	D1 D1尺寸 D1 Dimension (mm)	B2 隔齿齿距 Slot Pitch (mm)	D6 腿内面的尺寸 Foot Width(Inner) (mm)	D6g 腿外面的尺寸 Foot Width(Outer) (mm)
KM-50NA	PFA	25	142.24	153.00	145.50	13.97	4.76	76.20	86.20
KM-50NAT	PFA	25	142.24	153.00	145.50	13.97	4.76	76.20	86.20
KM-50NM	PFA	25	142.24	153.00	146.00	13.97	4.76	108.00	118.00
KM-50WD	PFA	25	143.38	153.00	146.00	14.54	4.76	50.00	58.00
KM-507-U	PFA	25	142.24	153.00	144.50	13.97	4.76	76.20	86.20
KM-510A	PFA	50	143.38	153.00	146.00	14.54	2.38	76.00	85.00
K-1	PFA	25	143.38	177.80	171.45	14.54	4.76	88.90	98.50
K-2	PFA	25	143.38	177.80	171.45	14.54	4.76	88.90	98.50

5inch PEEK Cassette

- 可以在高温阶段使用
- 防止帯電PEEK盒子(除了CW-05)

•Can be used in high temperature environments
•All antistatic PEEK cassettes except for the CW-05



125
mm

CW-05

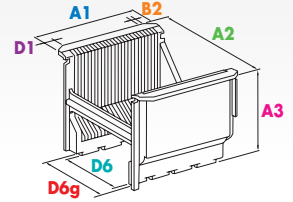

产品号码 Number	材料性质 Material	存放片数 Wafer Capacity	A1 全长 Length (mm)	A2 最大宽度 Width (mm)	A3 全高 Height (mm)	D1 D1尺寸 D1 Dimension (mm)	B2 隔槽齿距 Slot Pitch (mm)	D6 腿内面的尺寸 Foot Width(Inner) (mm)	D6g 腿外面的尺寸 Foot Width(Outer) (mm)
CW-05	PEEK	25	143.24	152.40	146.05	13.97	4.76	72.60	77.60
CW-05KE	PEEK+CP	25	143.24	152.40	146.05	13.97	4.76	72.60	77.60
CW-05KE-T2	PEEK+CP	25	143.24	152.40	146.05	13.97	4.76	72.60	77.60
KM-509K-SA	PEEK+CP	25	142.24	153.00	138.00	13.97	4.76	77.00	85.00
KM-509K-SU	PEEK+CP	25	142.24	153.00	138.00	13.97	4.76	77.00	85.00

5inch NEO Cassette

- 由PBT为基本用电导材复合的材料使用

•Antistatic PBT cassette made using compound conductive materials on a PBT base.



125
mm

KM-511NE-SH

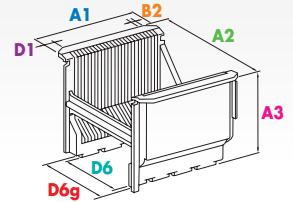

产品号码 Number	材料性质 Material	存放片数 Wafer Capacity	A1 全长 Length (mm)	A2 最大宽度 Width (mm)	A3 全高 Height (mm)	D1 D1尺寸 D1 Dimension (mm)	B2 隔槽齿距 Slot Pitch (mm)	D6 腿内面的尺寸 Foot Width(Inner) (mm)	D6g 腿外面的尺寸 Foot Width(Outer) (mm)
KM-511NE-SH	NEO	25	142.24	153.80	146.00	13.97	4.76	76.60	81.80

5inch PBT/PP Cassette

125
mm

- 削磨性, 低释气的盒子 (PBT)
- 相对抵抗药品性能很好 (PP)

- Abrasion resistant and low outgas cassette (PBT)
- Comparatively strong resistance to chemicals (PP)

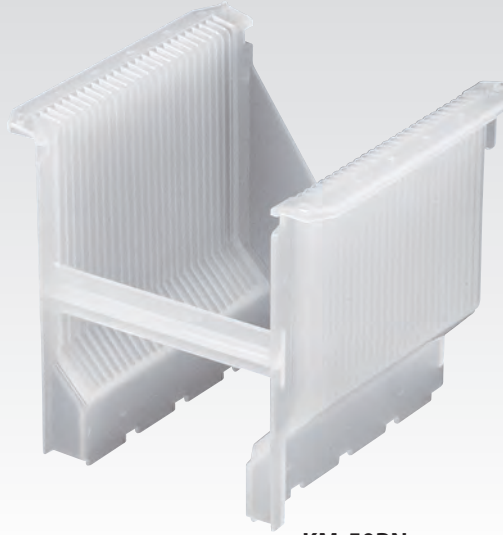

KM-50PN

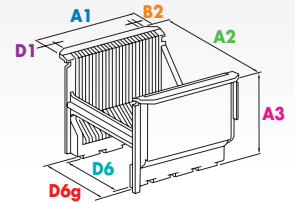

产品号码 Number	材料性质 Material	存放片数 Wafer Capacity	A1 全长 Length (mm)	A2 最大宽度 Width (mm)	A3 全高 Height (mm)	D1 D1尺寸 D1 Dimension (mm)	B2 隔槽齿距 Slot Pitch (mm)	D6 腿内面的尺寸 Foot Width(Inner) (mm)	D6g 腿外面的尺寸 Foot Width(Outer) (mm)
KM-511T-SH	PBT	25	142.24	153.80	146.00	13.97	4.76	76.60	81.80
KM-50PN	PP	25	142.24	153.00	145.50	13.97	4.76	76.20	82.40
KM-50PN-H	PP	25	142.24	153.00	145.50	13.97	4.76	76.20	82.40

4inch PFA Cassette

100
mm

- KM-40NA是H Bar加强型
- 重视清洗性(要采取宽阔的开孔面积)
- KM-1005与125mm盒子的外形尺寸相同

- KM-40NA is bar-reinforced
- Designed with emphasis given to washability (wide openings)
- KM-1005 is 100mm wafer cassette which have 125mm wafer cassette's silhouette

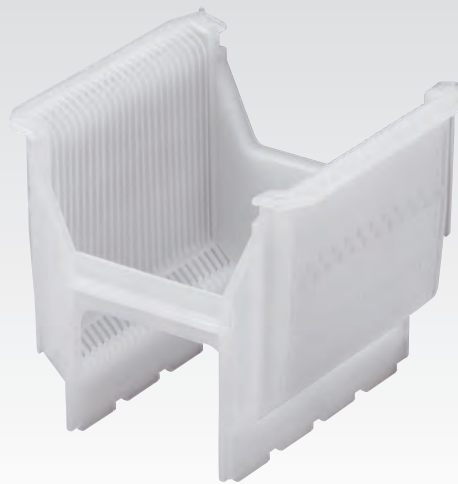

KM-40NA

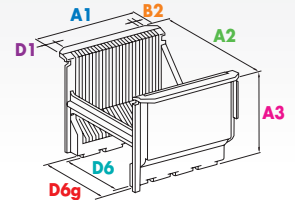

产品号码 Number	材料性质 Material	存放片数 Wafer Capacity	A1 全长 Length (mm)	A2 最大宽度 Width (mm)	A3 全高 Height (mm)	D1 D1尺寸 D1 Dimension (mm)	B2 隔槽齿距 Slot Pitch (mm)	D6 腿内面的尺寸 Foot Width(Inner) (mm)	D6g 腿外面的尺寸 Foot Width(Outer) (mm)
KM-40N	PFA	25	142.24	125.50	114.30	13.97	4.76	61.00	70.00
KM-40NA	PFA	25	142.24	125.50	114.30	13.97	4.76	61.00	71.00
KM-40S	PFA	25	142.24	124.50	114.30	13.97	4.76	61.60	71.60
KM-40WD	PFA	25	142.24	125.50	114.30	13.97	4.76	50.00	56.00
K-40	PFA	25	146.00	124.00	112.00	20.35	4.76	60.30	68.30
KM-1005	PFA	25	142.24	153.00	145.50	13.97	4.76	76.20	86.20

4inch PEEK Cassette

- 可以在高温阶段使用
- CW-04KE是防止带电PEEK盒子

·Can be used in high temperature environments
·CW-04KE is an antistatic PEEK cassette



100
mm

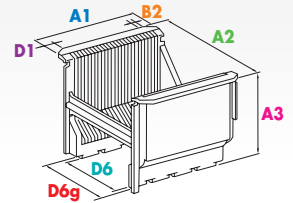

CW-04

产品号码 Number	材料性质 Material	存放片数 Wafer Capacity	A1 全长 Length (mm)	A2 最大宽度 Width (mm)	A3 全高 Height (mm)	D1 D1尺寸 D1 Dimension (mm)	B2 隔槽齿距 Slot Pitch (mm)	D6 腿内面的尺寸 Foot Width(Inner) (mm)	D6g 腿外面的尺寸 Foot Width(Outer) (mm)
CW-04	PEEK	25	142.24	126.48	111.12	13.97	4.76	60.33	65.33
CW-04KE	PEEK+CP	25	142.68	125.48	111.12	13.97	4.76	60.33	65.33

4inch PP Cassette

- 保管,搬运用的盒子

·Cassette for storage and transportation

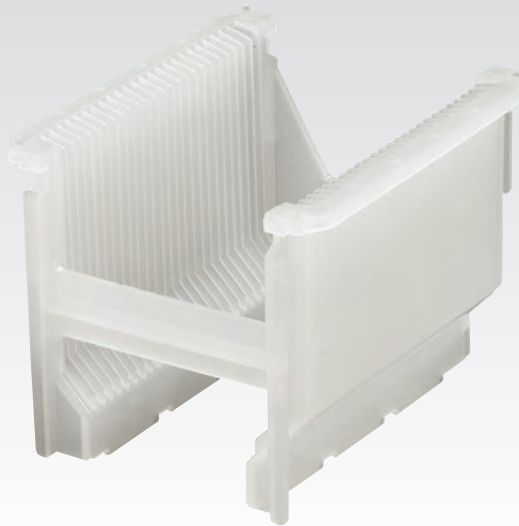

100
mm

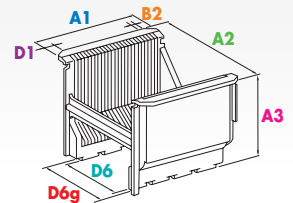

KM-40PN

产品号码 Number	材料性质 Material	存放片数 Wafer Capacity	A1 全长 Length (mm)	A2 最大宽度 Width (mm)	A3 全高 Height (mm)	D1 D1尺寸 D1 Dimension (mm)	B2 隔槽齿距 Slot Pitch (mm)	D6 腿内面的尺寸 Foot Width(Inner) (mm)	D6g 腿外面的尺寸 Foot Width(Outer) (mm)
KM-40PN	PP	25	142.24	124.50	114.30	13.97	4.76	61.60	68.60
KM-40MBP	PP	25	142.24	125.50	114.30	13.97	4.76	61.90	69.90

Under 3inch PFA Cassette

75
mm以下

- 重视清洗性(要采取宽阔的开孔面积)
- 使KM-25-51的齿距变得狭窄,因此一次能收藏51片的晶片

- Designed with emphasis given to washability (wide openings)
- Narrow slot pitch enables the KM-25-1 to hold 51 wafers at once

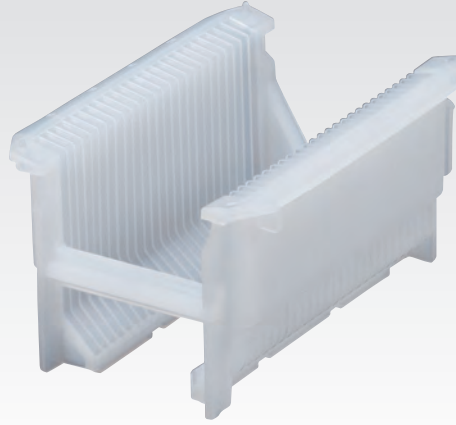

KM-30N

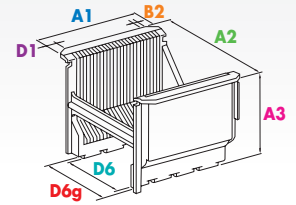

品番 Number	材質 Material	収納枚数 Wafer Capacity	A1 全長 Length (mm)	A2 最大幅 Width (mm)	A3 全高 Height (mm)	D1 D1寸法 D1 Dimension (mm)	B2 溝ピッチ Slot Pitch (mm)	D6 脚内寸 Foot Width(Inner) (mm)	D6g 脚外寸 Foot Width(Outer) (mm)
KM-30	PFA	25	142.25	93.60	83.00	13.90	4.76	38.50	47.90
KM-30N	PFA	25	142.24	102.80	82.60	13.97	4.76	38.90	47.90
KM-30WD	PFA	25	142.24	102.80	82.60	13.97	4.76	41.60	47.60
K-30	PFA	25	154.00	92.50	83.20	20.00	4.75	49.00	56.80
KM-25	PFA	25	142.24	78.00	73.20	13.97	4.76	48.60	58.50
KM-25-51	PFA	51	142.24	77.00	73.20	13.97	2.38	48.50	59.50
KM-20	PFA	25	142.10	67.80	59.00	13.90	4.76	34.00	45.20
K-20	PFA	25	150.00	67.00	54.00	18.00	4.75	31.00	38.00
K-15	PFA	25	151.00	58.00	45.50	18.35	4.76	24.00	29.00

Under 3inch PEEK/PP Cassette

75
mm以下

- 可以在高温阶段使用的防止带电PEEK盒子
- 相对抵化学性很能(PP)

- Antistatic PEEK cassette withstands high temperature environments
- Comparatively strong resistance to chemicals (PP)



KM-302KE-SA

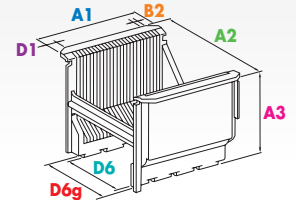

产品号码 Number	材料性质 Material	存放片数 Wafer Capacity	A1 全长 Length (mm)	A2 最大宽度 Width (mm)	A3 全高 Height (mm)	D1 D1尺寸 D1 Dimension (mm)	B2 隔沟齿距 Slot Pitch (mm)	D6 腿内面的尺寸 Foot Width(Inner) (mm)	D6g 腿外面的尺寸 Foot Width(Outer) (mm)
KM-302KE-SA	PEEK+CP	25	140.50	93.13	82.96	13.97	4.76	38.37	44.37
KM-302K-SA	PEEK	25	140.50	93.13	82.96	13.97	4.76	38.37	44.37
KM-30PN	PP	25	142.24	94.00	82.60	13.97	4.76	38.90	44.90

PFA Cassette For Square Wafers

- 150MASK是清洗150mm圆型 Mask glass使用的盒子
- KM-513-MA是清洗125mm角型Mask glass使用的盒子
- KM-514P-MA是保管,搬运125mm角型Mask glass使用的盒子
- 100MASK是清洗100mm角型Mask glass使用的盒子
- 60MASK是清洗60mm角型Mask glass使用的盒子
- 50MASK是清洗50mm角型Mask glass使用的盒子
- AM-100是清洗100mm太阳能电池使用的盒子

- 150MASK is a 150 mm round mask glass washing cassette
- KM-513-MA is a 125 mm square mask glass washing cassette
- KM-514P-MA is for carrying and keeping 125mm square grass mask
- 100-MASK is a 100 mm square mask glass washing cassette
- 60MASK is a 60 mm square mask glass washing cassette
- 50MASK is a 50 mm square mask glass washing cassette
- AM-100 is a 100 mm solar cell wafer washing cassette

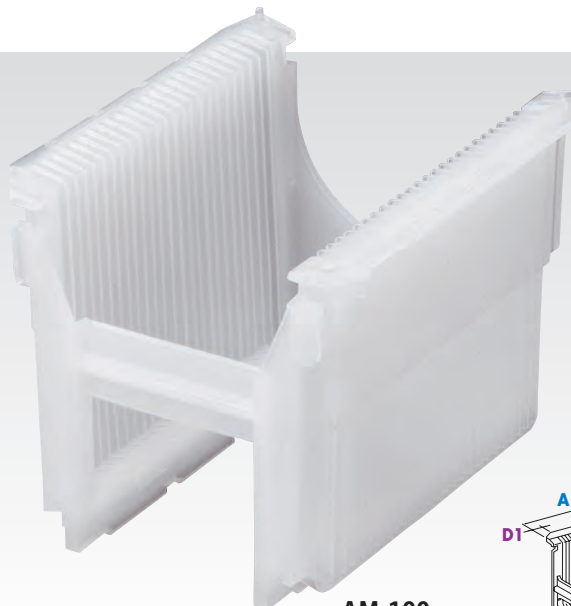

AM-100

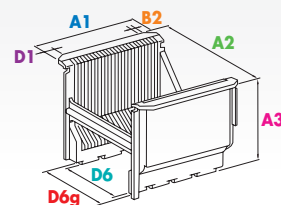

产品号码 Number	材料性质 Material	存放片数 Wafer Capacity	A1 全长 Length (mm)	A2 最大宽度 Width (mm)	A3 全高 Height (mm)	D1 D1尺寸 D1 Dimension (mm)	B2 隔网齿距 Slot Pitch (mm)	D6 腿内面的尺寸 Foot Width(Inner) (mm)	D6g 腿外面的尺寸 Foot Width(Outer) (mm)
150MASK	PFA	13	142.70	187.00	165.00	14.20	9.525	89.00	101.00
KM-513-MA	PFA	20	158.00	153.00	115.00	—	6.35	85.00	95.00
KM-514P-MA	PFA	25	143.38	153.00	140.00	14.52	4.76	76.20	86.20
AM-100	PFA	25	142.24	125.50	120.00	13.97	4.76	62.00	72.00
100MASK	PFA	20	155.95	125.00	78.00	—	6.35	85.00	95.00
60MASK	PFA	25	143.00	78.00	57.00	17.85	4.76	47.00	57.00
50MASK	PFA	25	142.10	68.00	70.00	13.97	4.76	36.70	46.70

Aluminium Cassette

- 又铝作推出加工,表面可以用特氟隆(聚四氟乙烯)涂膜处理
- 至于隔网板表面的处理可以用氟树脂涂膜(灰色,黑色),阳极氧化铝,Ni镀金处理
- 关于规格外的尺寸也可以应付
- 把手等的选项也可以应付

- Aluminium extrusion allows Teflon or alumite coating on the surface
- For wafer guide Teflon (gray or black), alumite and nickel plate coatings are available
- Non-standard dimensions can be specially arranged
- Handle and other options available

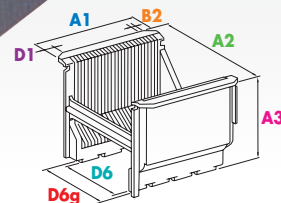
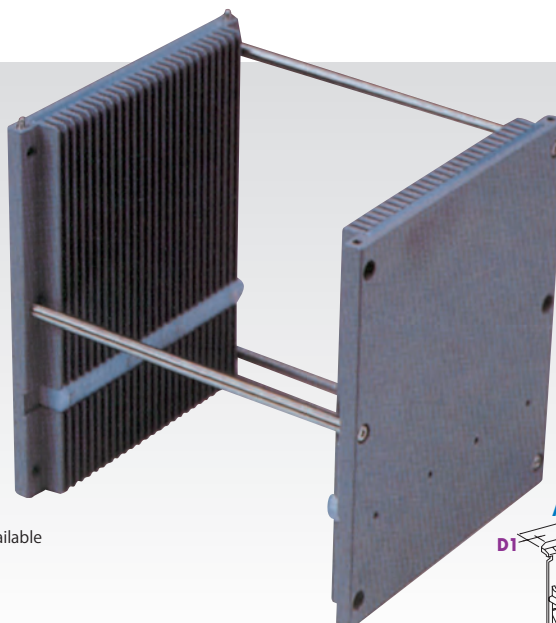

产品号码 Number	材料性质 Material	BL BL尺寸 BL Dimension (mm)	A1 全长 Length (mm)	A2 最大宽度 Width (mm)	A3 全高 Height (mm)	D1 D1尺寸 D1 Dimension (mm)	B2 隔网齿距 Slot Pitch (mm)
MC-80-25改	aluminium	200.00	203.20	216.00	217.40	25.40	6.35
MC-60	aluminium	149.00	142.24	165.00	165.00	13.97	4.76
MC-50	aluminium	124.00	142.24	140.00	140.00	13.97	4.76
MC-40	aluminium	100.00	142.24	116.00	110.00	13.97	4.76
MC-30	aluminium	75.00	142.24	91.00	88.00	13.97	4.76